

permobil



Products.

# Global company. Individual care.



## Our History

50 years ago Permobil was born in Timrå, Sweden, in a basement workshop owned by the inventor, entrepreneur and doctor, Per Uddén. Per Uddén was in many regards an unusual person. He was driven by an irresistible desire to discover new solutions for the questions which confronted him in his work as a doctor. Dr. Uddén had many ideas for improving the quality of life of people with disabilities. He believed that everyone had the right to a full life, to the extent of their potential. The electric wheelchair was an idea that in the mid-1960s led to an initial prototype. This electric wheelchair had unique technical solutions for its time, such as powered seat tilt, fold-away armrests and leg rests, and front wheel drive. Per Uddén was a true pioneer and we are proud to follow in his footsteps and that the company bears his name – 'Permobil'. In 1965 our founder, Per Uddén, declared, 'Every person with disabilities has the right to compensate as far as possible for his or her handicap with aids of the same technical standard as those we all use in our daily lives.' The creativity, curiosity and humanistic world view characteristic of Per Uddén and his work formed the basis on which Permobil now stands. Today, tens of thousands people around the entire world experience a richer life, thanks to this unusual person and his ideas.

## Our Vision

We at Permobil have by now met and got to know tens of thousands of people who have described the reality of their lives, their dreams and their needs for us. We got to work with this information and are now an important part of their lives with our products and services. We focus on the person and their needs at all times. Perhaps this is the reason why our products and services are regarded so highly. Our products are the result of a unique cooperation between users, occupational therapists and the whole of our organisation. Permobil's ambition is to be a world-renowned supplier of advanced mobility solutions and accessories for people with a physical disability. We want to exceed the expectations of our customers with the aid of top employees, top quality and innovations.

## Our Mission

To give people with a disability greater mobility and quality of life by means of technology. Permobil develops and produces electric wheelchairs, transport solutions and communication systems, and markets them to people with disabilities. Our products have to offer help at a time when quality, performance, safety and functionality are important. We want our products to offer our users the best possible compensation for their disabilities.

## Taking care of tomorrow today

Responsibility and commitment to environmental issues are an element of our tradition and a natural aspect of the way in which we work. We have a global responsibility to do everything we can in our work to contribute to the positive development of a more sustainable society. Our environmental policy is the compass that shows us the direction we must take each day. Permobil promotes an ecologically more sustainable society by saving resources and considering the environment and making the right choices concerning products, activities and services.

## Certification

A global business has worldwide distribution channels. All our production sites around the world ask their suppliers to comply with the Terms and Conditions of Purchase and Guidelines of our business. Acceptance and compliance with our terms and guidelines means that our global distribution network functions in accordance with the requirements of ISO 9001 or ISO 13485, ISO 14001 and ISO 26000. To become a preferred supplier and be qualified to work with our business we expect our suppliers to accept our terms and guidelines in a written agreement.

## Quality is part of our tradition

Quality is one of the cornerstones of our business. We have always had big ambitions and our products and services bear a quality mark that we are proud of and that we are continuing to develop. A business with ambitions like these can never be complacent. Quality has to be constantly improved and this has to be a natural part of our daily activities. So our business is also shaped by a quality assurance system which we use to compare our performance with the expectations of our customers. This means that there are systematic checks in all our processes to monitor that we continually meet approved specifications. This policy applies to the entire concern and also to our external suppliers.



We have met and got to know tens of thousands of people who have described the reality of their lives, their dreams and needs for us. With our products and services we have become an important part of their lives. To have such a good, strong relationship with your customers is a privilege. It is also an important reason why our products and services are so highly regarded. Our products are the result of a unique cooperation between users, occupational therapists and our entire organization. These days we have a phenomenal range of chassis and seats for adults as well as for children and teenagers, suitable for indoor and outdoor use. We have a worldwide support and service organization which guarantees safety and positive cooperation throughout the entire life of the wheelchair. Looking to the future, we are committed to bringing the latest technology to our customers, transforming the wheelchair into a natural platform for movement, communication and interaction with the environment.

**Jon Sintorn** President and CEO





ADULTS	STANDARD	CHILDREN	OUTDOOR	LIFESTAND	SOLUTIONS
06 F5 Corpus	20 C300 Corpus 3G	30 M400 PS JR	40 X850 Corpus 3G	44 LS - LSE	56 Customization
08 F5 Corpus VS	22 C300 TS	32 K300 PS JR		46 LSA	58 Mobility
10 C400 Corpus 3G Lowrider	24 C350 Corpus 3G	34 K450 MX		48 LSR	66 Comfort
12 C500 Corpus 3G Lowrider	26 C350 TS	36 Koala Miniflex		50 LSR KID	74 Control
14 M400 Corpus 3G					84 Accessories
16 M400 Corpus HD					88 Contact
				52 New brand Tilite	



M400 CORPUS HD



M400 CORPUS 3G



C500 LOWRIDER



C400 LOWRIDER



F5 CORPUS VS



F5 CORPUS

Adults.



## SPECIFICATIONS

Length	1140 mm
Width	655 - 790 mm
Height	960 - 1170 mm
Min. transport length	825/930 mm
Seat height	450 mm
Seat height with electric seat lift	450 - 800 mm
Weight incl. batteries	186 kg
Max. user weight	150 kg
Seat width	420 - 570 mm (by 50 mm)
Seat depth	370 - 570 mm (by 25 mm)
Backrest width	360/410/460/510 mm
Backrest height	470 - 670 mm (by 25 mm)
Distance between armrests	380 - 480/480 - 580 mm
Backrest angle - adjustable	120°(manual), 150° & 180°(power)
Armrest height	185 - 320 mm
Legrest angle - adjustable	90° - 180°
Battery capacity	2 x 73 Ah
Range	25 - 35 km
Max. speed	12 km/h
Turning radius (ISO 7176-5)	735 mm
Turning in corridor	1140 mm
Obstacle capability	70 - 80 mm
Electronics R-net	120 A
Electric tilt adjustment (posterior)	50°
Electric tilt adjustment (anterior)	10°/20°/45°
ISO 7176-19/ISO 10542-3	Yes - crash tested
EN12182/EN12184 CE	Yes

## FUNCTIONS

### Electrical functions



Tone, reach and transfer



Tilt adjustment



Seat lift



Leg rest adjustment



Backrest adjustment

### Colours



sunburst orange



radiant red



power pink



galactic green



ocean blue



titan blue

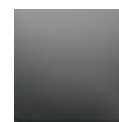

phantom grey



midnight black

### Upholstery



leatherette

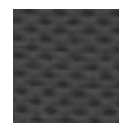

fabric



# The combi-chair of the future.

## Comfort, Performance and Stability

The **F5 Corpus** is a durable, powerful and stable front wheel drive power wheelchair combined with the best seating system on the market – the Corpus seat. The seating system is designed to effectively support the clinical, functional and lifestyle needs of active users. The latest version of the Corpus offers five optional power seat functions. The possibility to have programmable anterior tilt is now a standard option. In developing the F5 chassis we have placed great emphasis on fine-tuning suspension and ride comfort. Coupled to powerful motors, this makes for great performance and a stable, confidence-inspiring driving experience. A range of alternative driving controls for non-joystick drivers is available, as well as separate controls for assistants/caregivers. For transport purposes, the upper part of the backrest can be removed to reduce the overall size of the wheelchair.

### FEATURES

#### Independence

Capable of raising you 35cm, the AP seat elevator gives users unparalleled functional independence and access.



#### Control

The latest driving and seat positioning controls. Full colour LCD display with memory functions, speedometer and clock.



#### Comfort Ride™

Fully independent suspension in a finely tuned power base provides a higher level of comfort and stability, indoor and outdoor. Saving your energy for the important things in life.



#### Performance

Powerful new motors combined with front wheel drive and ESP (Enhanced Steering Performance) give you speed and freedom of movement. Go where you want to go.



# F5 Corpus VS



## SPECIFICATIONS

Length	1145 mm
Width	655 - 790 mm
Height	960 - 1170 mm
Min. transport length	980 mm
Seat height	450 mm
VWeight incl. batteries	196 kg
Max. user weight 'Sit-to-stand'	136 kg (max 80°)
Max user weight 'Lay-to-Stand'	100 kg (max 80°)
Seat width	420 - 570 mm (by 50 mm)
Seat depth	370 - 570 mm (by 25 mm)
Backrest width	360/410/460/510 mm
Backrest height	595/620/645/670 mm
Distance between armrests	380 - 480/480 - 580 mm
Backrest angle – adjustable	180°
Armrest height	215 - 330 mm
Legrest angle – adjustable	90° - 180°
Battery capacity	2 x 73 Ah
Range	25 - 35 km
Max. speed	12 km/h
Turning radius (ISO 7176-5)	745 mm
Turning in corridor	1140 mm
Obstacle capability	60 - 75 mm
Electronics R-net	120 A
Electric tilt adjustment	50°
Electric stand-up function	Yes
ISO 7176-19/ISO 10542-3	Yes – crash tested
EN12182/EN12184 CE	Yes

## FUNCTIONS

### Electrical functions

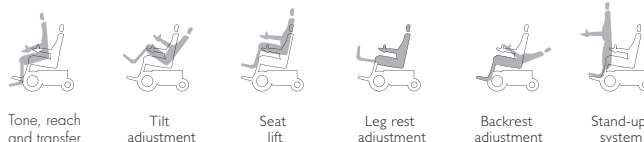

### Colours



### Upholstery

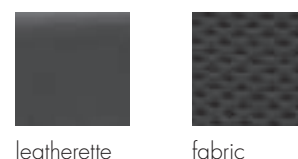

# Get vertical.

## Stability, Comfort, Performance

The **F5 Corpus VS** is a durable, powerful and stable front wheel drive power wheelchair combined with the best seating system on the market – the Corpus seat. The seating system is designed to effectively support the clinical, functional and lifestyle needs of active users. The latest version of the Vertical Stander (VS) offers all the power seat functions of the Corpus seat plus an innovative new way of standing, allowing you to choose from two positions, Sit-to-stand or Lay-to-stand. Giving you greater independence and freedom, the F5 Corpus VS features fully independent suspension and automatic, self-adjusting support wheels, providing a new level of comfort and stability, especially when you stand and drive, indoors or outdoors! A range of alternative driving controls for non-joystick drivers is available, as well as separate controls for assistants/caregivers. For transport purposes, the upper part of the backrest can be removed to reduce the overall size of the wheelchair.

### FEATURES

#### Stand and drive

Choose between Sit-to-stand or Lay-to-stand, or have both! Stand and drive mode is also made easier at any standing angle.



#### Control

The latest driving and seat positioning controls. Full colour LCD display with memory functions, speedometer and clock.



#### Comfort

All the benefits of the ergonomically designed Corpus seating system are now available on the Corpus VS.



#### Stability

Powered self-adjusting support wheels for stability while standing and safe negotiation of obstacles while standing and driving.



# C400

CORPUS **EG**



## SPECIFICATIONS

Total length	1130 mm
Total width	620 mm
Minimum transport length	900 mm
Seat height	465 mm
Seat height Lowrider	405 mm
Total weight incl. batteries	175 kg
Maximum user weight	136 kg
Seat width	420 - 570 mm (by 50 mm)
Seat depth	370 - 570 mm (by 25 mm)
Backrest width	360 - 410 - 460 - 510 mm
Backrest height	470, 545 - 670 mm (by 25 mm)
Armrest height	230 - 330 mm
Backrest angle - adjustable	85° - 175°
Legrest angle - adjustable	85° - 170°
Battery capacity	2 x 73 Ah
Range (ISO 7176-4)	30 - 35 km
Maximum speed	7.5 km/h
Turning radius (ISO 7176-5)	665 mm
Obstacle height	60 mm
Suspension	yes
Electronics	R-net
Powered seat lift	option, 200 mm (LR: 140 mm)
Powered seat tilt	option, 0° - 50° or -5° - 45°
Powered seat tilt Lowrider	option, 0° - 30° or -5° - 25°
Powered leg rest adjustment	option
Powered backrest adjustment	option
ISO 7176-19/ISO 10542-3	yes - crash tested
EN12182/EN12184 CE	yes

## FUNCTIONS

### Electrical functions

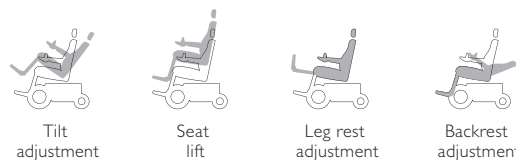

### Colours

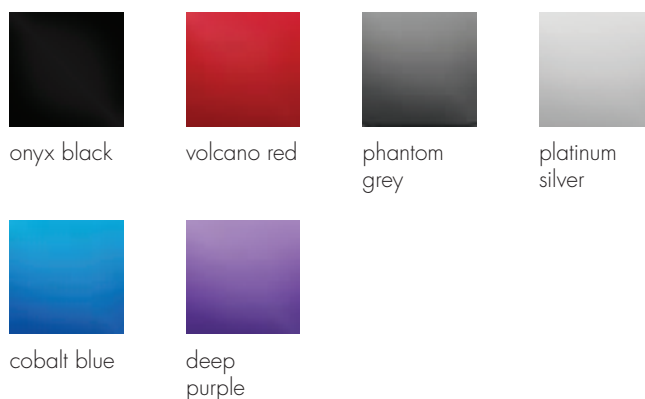

### Upholstery

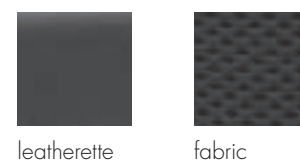



# Enjoy comfort.

## Stability and manoeuvrability

The **C400 Corpus 3G** with a lowrider version combines an innovative design with advanced technology. The C400 with ESP (Enhanced Steering Performance) is compact and combines great indoor manoeuvrability with excellent outdoor performance. The C400 is the perfect example of Permobil's technical ingenuity. The modular design of the Corpus 3G seating system offers improved functionality with its adjustable seat dimensions and powered settings. The Corpus 3G has been designed by one of the world's leading ergonomist. The result is a seating system that is fully adapted to the natural form of the body. The Corpus 3G seating system is endlessly adaptable. The depth, width, height and angle of the various chair elements can be regulated or adjusted. The ergonomically-shaped seat and the optional powered settings make the Corpus 3G the most popular seating system in the world.

### FEATURES

#### Extra low seat height

The lowrider version has a very low seatheight of 405 mm in combination with all powered functions. So it's ideal, for example, for driving a car independently or sitting comfortably at tables of standard height.



#### Control

R-net electronics: intelligent control system (ICS) with programmable settings.



#### Transfer legrest

An ingenious combination of various powered settings which helps you to transfer more safely and simply.



#### Power extension legrest

Transfer weight and pressure, improved, positioning while resting etc.





# C500

CORPUS **3G**



## SPECIFICATIONS

Total length	1225 mm
Total width	675 mm
Minimum transport length	930 mm
Seat height	465 mm
Seat height Lowrider	405 mm
Total weight incl. batteries	181 kg
Maximum user weight	136 kg
Seat width	420 - 570 mm (by 50 mm)
Seat depth	370 - 570 mm (by 25 mm)
Backrest width	360 - 410 - 460 - 510 mm
Backrest height	470, 545 - 670 mm (by 25 mm)
Armrest height	230 - 330 mm
Backrest angle - adjustable	85° - 175°
Legrest angle - adjustable	85° - 170°
Battery capacity	2 x 73 Ah
Range (ISO 7176-4)	30 - 40 km
Maximum speed	8 - 10 km/h
Turning radius (ISO 7176-5)	715 mm
Obstacle height	70 mm
Suspension	yes
Electronics	R-net
Powered seat lift	option, 200 mm (LR: 140 mm)
Powered seat tilt	option, 0° - 50° or -5° - 45°
Powered seat tilt Lowrider	option, 0° - 30° or -5° - 25°
Powered leg rest adjustment	option
Powered backrest adjustment	option
ISO 7176-19/ISO 10542-3	yes - crash tested
EN12182/EN12184 CE	yes

## FUNCTIONS

### Electrical functions

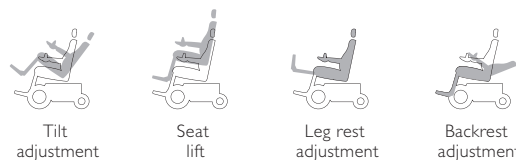

### Colours

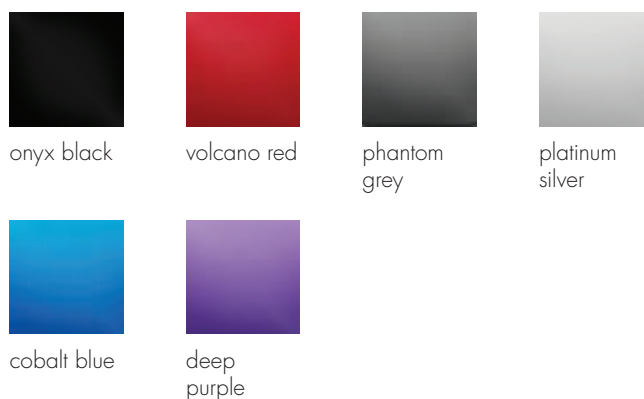

### Upholstery

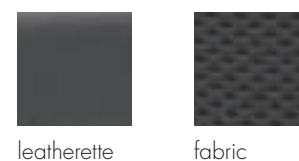

# The ideal combi-chair.

## Stability and manoeuvrability

The **C500 Corpus 3G** with a Lowrider version represents the timeless, classic values of Permobil: unrivalled quality, advanced technology and the very best forms of functionality. Even the smallest detail has been taken into account in the design of this chassis. This is without doubt a very comfortable wheelchair. Its unparalleled strength, good manoeuvrability and ESP (Enhanced Steering Performance) make dealing with obstacles easy. As the C500 makes use of the Corpus 3G seating system, this chair also offers you improved functionality with its adjustable seat dimensions and various powered settings. Thanks to the adaptability of the Corpus 3G seating system an endless variety of sitting and lying positions is possible, by adapting or adjusting the depth, width, height and angle of the different parts of the chair in numerous combinations. The ergonomic seat and the optional powered settings make the Corpus 3G the most popular seating system in the world amongst those who know.

### FEATURES

#### Extra low seat height

The Lowrider version has a very low seat height of 405 mm in combination with all powered functions. So it's ideal, for example, for driving a car independently or sitting comfortably at tables of standard height.



#### Control

R-net electronics: intelligent control system (ICS) with programmable settings.



#### Stand up system

An ingenious combination of various powered settings which helps you to transfer more safely and simply.



#### Power extension legrest

Transfer weight and pressure, improved, positioning while resting etc.



# M400

CORPUS 3G

 CRASH TESTED



## SPECIFICATIONS

Total length	1150 mm
Total width	620 mm
Minimum transport length	825 mm
Seat height	440 mm
Seat height with powered seat lift	440 - 640 mm
Total weight incl. batteries	177 kg
Maximum user weight	136 kg
Seat width	420 - 570 mm (by 50 mm)
Seat depth	370 - 570 mm (by 25 mm)
Backrest width	360 - 410 - 460 - 510 mm
Backrest height	470, 545 - 670 mm
Distance between armrests	380 - 580 mm
Backrest angle - adjustable	85° - 175°
Legrest angle - adjustable	85° - 170°
Battery capacity	2 x 60 Ah or 2 x 73 Ah
Range (ISO 7176-4)	30 - 35 km
Maximum speed	10 - 12 km/h
Turning radius (ISO 7176-5)	510 mm
Obstacle height	front 60 mm, rear 50 mm
Suspension	yes
Electronics	R-net 120 A
Powered seat lift	option, 200 mm
Powered seat tilt	option 0° - 50° or -5° - 45°
Powered leg rest adjustment	option
Powered backrest adjustment	option
ISO 7176-19/ISO 10542-3	yes - crash tested
EN12182/EN12184 CE	yes

## FUNCTIONS

### Electrical functions

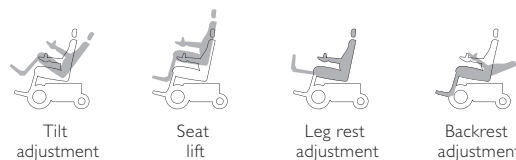

### Colours



### Upholstery

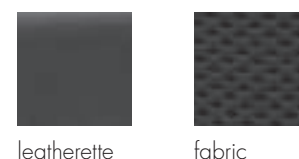

# Superior performance.

## Maximum manoeuvrability

Having launched the first mid-wheel drive platform to the wheelchair market nearly 30 years ago, Permobil honors that rich tradition with the addition of the **M400 Corpus 3G** to its product line. With its compact size, the M400 has a tight 510 mm turning radius, comes with PG 120 amp R-net electronics and offers a speed up to 12 km/h. The M400 also features stylish easy-to-replace swing arm covers made of scratch resistant material, which protect the swing arms from unsightly chips and scrapes. Easy to maintain, the M400 provides quick access to components and requires no special tools for servicing.

### FEATURES

#### Legrest

Curved legrest for a natural sitting posture.



#### Control

R-net electronics: intelligent control system (ICS) with programmable settings.



#### Wheel rims

Split rims available with hubcaps in same colour as coping.



#### Tie-downs

Safety is first both in and out of the vehicle. Front and rear tie-downs.



#### Climbing and traction link system

More grip and stability thanks to the unique suspension system linking the drive wheels with the caster wheels.



#### Turning radius

510 mm turning radius for increased maneuverability.



#### Shock design

Easily adjusted to provide a comfortable ride for any user.





# M400

CORPUS **HD**



## SPECIFICATIONS

Total length	1190 mm
Total width	660 mm
Minimum transport length	876 mm
Seat height	450 mm
Seat height with powered seat lift	450, 500 - 650 mm
Total weight incl. batteries	202 kg
Maximum user weight	205 kg
Seat width	470 - 620 mm (by 50 mm)
Seat depth	495 - 645 mm (by 25 mm)
Backrest width	510 - 560 - 610 mm
Backrest height	540, 620 - 745 mm (by 25 mm)
Armrest pad length	335, 410, 460 mm
Backrest angle - adjustable	power 85° - 150° manual 85° - 120°
Legrest angle - adjustable	85° - 175°
Battery capacity	2 x 73 Ah
Range (ISO 7176-4)	30 km
Maximum speed	8 km/h
Turning radius (ISO 7176-5)	560 mm
Motor power	2 x 350 Watt
Obstacle height	60 mm
Ground clearance	74 mm
Suspension	yes
Electronics	R-net
Powered seat lift	option, 200 mm
Powered seat tilt	option, 0° - 45°
Powered leg rest adjustment	option
Powered backrest adjustment	option
EN12182/EN12184 CE	yes

## FUNCTIONS

### Electrical functions



Tilt adjustment



Seat lift



Leg rest adjustment



Backrest adjustment

### Colours



onyx black



volcano red



sublime green



platinum silver



cobalt blue



deep purple



phantom grey



popstar pink

### Upholstery



leatherette

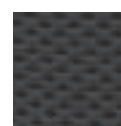

fabric



# Tough enough.

The corpus seating system, only stronger

Introducing the new **M400 Corpus HD**, a heavy duty power wheelchair designed specifically for users up to 205 kg. The HD has extremely sturdy arm and legrests as well as wider footplates for additional room, and it features the world-renowned Corpus seating system for the ultimate in comfort with an unmatched power tilt range of 0°-45° and an unprecedented recline of 85°-150°. The M400 base is highly maneuverable and has been both extended and widened for the HD model, while the suspension has been strengthened for an overall more stable platform. The ultra-strong actuators allow you to safely elevate your feet above your heart, while the durable mesh-style upholstery helps keep moisture away from the body. With the legendary power and toughness of Permobil, the M400 Corpus HD is built to withstand the rigors of any heavy duty lifestyle.

## FEATURES



### Legrest

Extremely durable, sturdy adjustable legrest.



### Footplates

Oversized, independently adjustable footplates.



### Strong actuators

Incredibly strong actuators for seat functions.



### Suspension

Independently adjustable suspension for a smooth ride under any condition.







C350 TS



C350 CORPUS 3G



C300 TS



C300 CORPUS 3G

Standard.



## SPECIFICATIONS

Total length	1080 mm
Total width	620 mm
Minimum transport length	885 mm
Seat height	440 mm
Seat height with powered seat lift	440 - 640 mm
Total weight incl. batteries	153 kg
Maximum user weight	136 kg
Seat width	420 - 570 mm (by 50 mm)
Seat depth	370 - 570 mm (by 25 mm)
Backrest width	360 - 410 - 460 - 510 mm
Backrest height	470, 545 - 670 mm
Backrest angle - power adjustable	85° - 175°
Backrest angle - manual adjustable	85° - 120°
Legrest angle - adjustable	85° - 170°
Battery capacity	2 x 60 Ah
Range (ISO 7176-4)	30 - 35 km
Maximum speed	7 km/h
Turning radius (ISO 7176-5)	610 mm
Obstacle height	70 mm
Suspension	yes
Electronics	R-net 90 A / 120 A
Powered seat lift	option, 200 mm
Powered seat tilt	option, 0° - 50° or -5° - 45°
Powered legrest adjustment	option
Powered backrest adjustment	option
ISO 7176-19	yes - crash tested
EN12182/EN12184 CE	yes

## FUNCTIONS

### Electrical functions



Tilt adjustment



Seat lift



Leg rest adjustment



Backrest adjustment

### Colours



onyx black



volcano red



cobalt blue

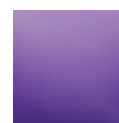

deep purple

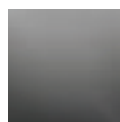

phantom grey



popstar pink

### Upholstery



leatherette

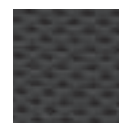

fabric

# Just the facts.

## Combining stability and agility

The **C300 Corpus 3G** gives you the high caliber performance you expect from Permobil. Its compact size lets you easily navigate tight spaces, while the powerful motors take you anywhere you need to go. The Corpus 3G Ergo Backrest mimics the shape and comfort of today's Corpus Backrest, but provides more functionality and adjustment. A powerful center-mounted actuator offers up to 50° of tilt, and you can recline up to a full 175°. The legrests are curved for better support, and the armrests feature built-in channels for cable routing, which significantly reduce the need for messy wire ties. All of this evidence of the ideal power wheelchair.

### FEATURES

#### Seat elevator

200 mm power seat elevator.



#### Lighting

Optionally available with energy efficient front and rear LED lighting.



#### Power tilt and recline

Power tilt and recline with elevating legrests, 50° of tilt with two range selections and 175° power recline.



#### Armrests

Independently adjustable armrest height, angle and pitch.



#### Legrest

Independently adjustable legrest height.



#### Suspension

The independent wheel suspension makes for comfortable and stable road handling.





# C300 TS

 CRASH TESTED



## SPECIFICATIONS

Total length	1080 mm
Total width	620 mm
Minimum transport length	885 mm
Seat height	460, 500 mm
Seat height with powered seat lift	460 - 660, 500 - 700 mm
Total weight incl. batteries	128 kg
Maximum user weight	136 kg
Seat width	380 - 430 - 480 - 530 mm
Seat depth	360 - 560 mm
Backrest width	380 - 430 - 480 - 530 mm
Backrest height	450 - 600 mm
Backrest angle - adjustable	90° - 125°
Legrest angle - adjustable	90° - 150°
Battery capacity	2 x 60 Ah
Range (ISO 7176-4)	30 - 35 km
Maximum speed	7 km/h
Turning radius (ISO 7176-5)	610 mm
Obstacle height	70 mm
Suspension	yes
Electronics	VR2
Powered seat lift	option, 200 mm
Powered seat tilt	option
Powered legrest adjustment	option
Powered backrest adjustment	option
ISO 7176-19/ISO 10542-3	yes - crash tested
EN12182/EN12184 CE	yes

## FUNCTIONS

### Electrical functions



Tilt adjustment



Seat lift



Leg rest adjustment



Backrest adjustment

### Colours



onyx black



volcano red



cobalt blue



deep purple

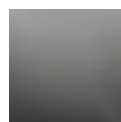

phantom grey



popstar pink

### Upholstery



fabric

# Simply magnificent.

Manoeuvrable, adjustable and economical

The **C300 TS** offers the best possible combination of capacity, stability, sitting comfort and manoeuvrability in its class for the best total price. The TS seating system is highly adjustable and remarkably versatile. Thanks to the integrated UniTrack profile, the seat depth, the height of the armrests and the position of the lumbar pads can all be adjusted very quickly and easily. The low standard seat height offers optimum functionality. Four electrical adjustments are optionally available: seat lift, tilt, back and leg angle adjustment. Special positioning accessories offering the user additional support are also available, such as calf, thigh and lumbar supports and headrests.

## FEATURES

### Control

VR2 electronics with expansion for four settings via the joystick.



### Seat

Steplessly adjustable seat depth and armrest height.



### Functions

Optional powered back and/or seat tilt, seat lift 200 mm and biomechanical leg support.



### Seat

Webbed backrest and seat with adjustable velcro straps for a high level of flexibility.



### Lighting

Optionally available with energy efficient front and rear LED lighting.



### Suspension

The independent wheel suspension offers comfortable and stable handling.



# C350

CORPUS IG



## SPECIFICATIONS

Total length	1180 mm
Total width	625 mm
Minimum transport length	955 mm
Seat height	450 mm
Seat height with powered seat lift	450 - 650 mm
Total weight incl. batteries	149 kg
Maximum user weight	136 kg
Seat width	420 - 570 mm (by 50 mm)
Seat depth	370 - 570 mm (by 25 mm)
Backrest width	360 - 410 - 460 - 510 mm
Backrest height	470, 545 - 670 mm
Backrest angle - adjustable	85° - 150°
Leg rest angle - adjustable	85° - 170°
Battery capacity	2 x 60 Ah
Range (ISO 7176-4)	30 - 35 km
Maximum speed	10 km/h
Turning radius (ISO 7176-5)	665 mm
Obstacle height	70 mm
Suspension	yes
Electronics	R-net 120 A
Powered seat lift	option, 200 mm
Powered seat tilt	option, 0° - 50° or -5° - 45°
Powered legrest adjustment	option
Powered backrest adjustment	option
ISO 7176-19	yes - crash tested
EN12182/EN12184 CE	yes

## FUNCTIONS

### Electrical functions

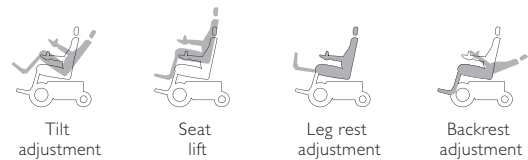

### Colours

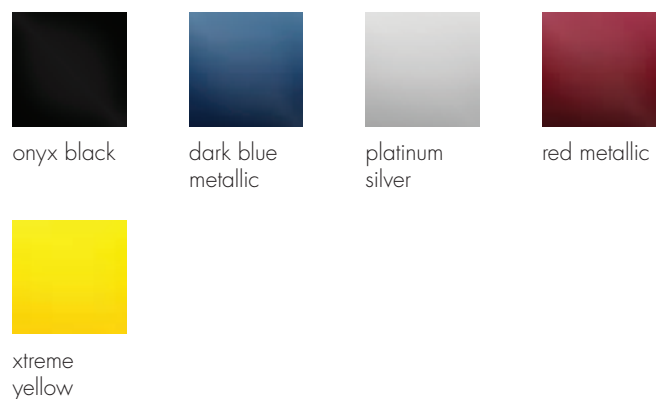

### Upholstery

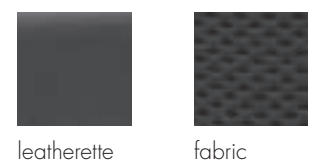

# Dynamic by design.

The ultimate in engineering and ergonomics

Featuring a rear-wheel drive power base and a maximum speed of 10 km/h, the **C350 Corpus 3G** can easily keep pace with your busy lifestyle. Plus, the Corpus 3G seating system is designed for comfort beyond comparison, something you need in today's fast-paced world. The seating system follows the contours of the body, offers infinite adjustments for a custom fit and reclines 150°. The armrests feature built-in channels for cable routing, which greatly reduces the need for messy wire ties; while the legrests are curved for better support. Blending form and function, the C350 Corpus 3G is the ideal blueprint for mobility.

## FEATURES

### Recline

Up to 150° of powered recline to find 'just the right level' of comfort.



### Tilt

Up to 50° of powered tilt with two range selections for valuable repositioning.



### Suspension

4-wheel adjustable independent suspension for the ultimate ride quality.



### Armrests

Independent and angle adjustable armrest height, with convenient flip-up feature.





# C350 TS



## SPECIFICATIONS

Total length	1065 mm
Total width	625 mm
Minimum transport length	900 mm
Seat height (fixed)	460, 500 mm
Seat height with powered seat lift	460 - 660, 500 - 700 mm
Total weight incl. batteries	130 kg
Maximum user weight	136 kg
Seat width	380 - 430 - 480 - 530 mm
Seat depth	360 - 560 mm
Backrest width	380 - 430 - 480 - 530 mm
Backrest height	450 - 600 mm
Distance between armrests	380 - 530 mm
Backrest angle - adjustable	90° - 125°
Legrest angle - adjustable	90° - 150°
Battery capacity	2 x 60 Ah
Range (ISO 7176-4)	30 - 35 km
Maximum speed	10 km/h
Turning radius (ISO 7176-5)	665 mm
Obstacle height	70 mm
Suspension	yes
Electronics	VR2
Powered seat lift	option, 200 mm
Powered seat tilt	option
Powered legrest adjustment	option
Powered backrest adjustment	option
ISO 7176-19/ISO 10542-3	yes - crash tested
EN12182/EN12184 CE	yes

## FUNCTIONS

### Electrical functions

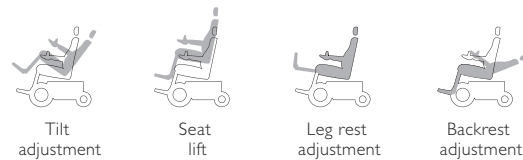

### Colours



### Upholstery





# Flexibility is limitless.

Manoeuvrable, adjustable and economical

You will find the streamlined design and powerful capacity you expect from Permobil's high-quality electric wheelchairs in the **C350 TS** (Tension Seat). The C350 TS offers a perfect combination of stability, comfort and manoeuvrability. The TS seating system is characterised by its versatility and adaptability. Thanks to the durable integrated Unitrack tubular profile you can quickly and easily adjust the seat depth, armrest height and position of torso supports, etc. Powered adjustment of the seat lift, seat tilt, back and leg rest positions is optionally available. The seat height remains the same, regardless of any other powered setting adjustments. The TS seat can also be set at different seat heights and angles. Its potential is unrivalled: there are two types of leg support available, the armrests can be raised up or angled and there is a selection of positioning accessories, e.g. thigh supports, torso supports, calf supports and head support for optimal comfort of the user.

## FEATURES

### Control

VR2 electronics with expansion for four settings via the joystick.



### Seat

Steplessly adjustable seat depth and armrest height.



### Wheel rims

Split rims available with hubcaps in same colour as coping.



### Seat

Webbed backrest and seat with adjustable velcro straps for a high level of flexibility.



### Seat tilt

Optional powered back and/or seat tilt, seat lift 200 mm and biomechanical legrest.



### Suspension

The independent wheel suspension can be adjusted to the user's weight for smooth and stable handling.







KOALA MINIFLEX



K450 MX



K300 PS JR



M400 PS JR

Children.

# M400

PS JR



## SPECIFICATIONS

Total length	925 mm
Total width	620 mm
Minimum transport length	826 mm
Seat height	430 mm
Seat height with powered seat lift	430 - 630 mm
Total weight incl. batteries	142 kg
Maximum user weight	75 kg
Seat width	275 - 400 mm
Seat depth	250 - 450 mm
Backrest width	275 - 400 mm
Backrest height	350 - 560 mm
Backrest angle - adjustable	85° - 120°
Legrest angle - adjustable	85° - 170°
Battery capacity	2 x 60 Ah - 2 x 73 Ah
Range (ISO 7176-4)	30 - 35 km
Maximum speed	10 - 12 km/h
Turning radius (ISO 7176-5)	510 mm
Obstacle height	front 60, rear 50 mm
Suspension	yes
Electronics	R-net
Powered seat lift	option, 200 mm
Powered seat tilt	option, 0° - 45°
Powered legrest adjustment	option, special adaptation
Powered backrest adjustment	option, special adaptation
EN12182/EN12184 CE	yes

## FUNCTIONS

### Electrical functions

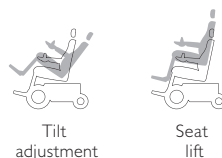

### Colours



### Upholstery

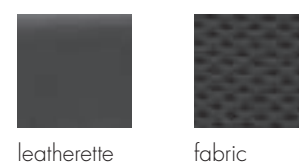

# Adventure awaits.

Indoors or out!

The **M400 PS Junior** combines the capabilities of our M400 base with the versatility of the PS Junior seating system for the perfect pediatric chair. With a tight turning radius, your child will be able to maneuver through your home with ease. The expandable seat pan allows for a custom fit, so the chair can grow with the child. Plus, the PS Junior is designed with convenient flip-back armrests, making transfers a breeze. And thanks to the UniTrack, standard on the PS Junior, you can have a variety of adjustments and accessories for added comfort.

## FEATURES

### Armrests

Armrests flip back completely out of the way for easier transfers.



### Turning radius

510 mm turning radius for increased maneuverability.



### Legrest

Adjustable legrest allow for better positioning.



### Suspension

Casters are connected for added climbing stability.





# K300

## PS JUNIOR



### SPECIFICATIONS

Total length	1080 mm
Total width	620 mm
Minimum transport length	885 mm
Seat height	430 mm
Seat height with powered seat lift	430 - 630 mm
Total weight incl. batteries	109 kg
Maximum user weight	76 kg
Seat width	275 - 400 mm
Seat depth	250 - 450 mm
Backrest width	275 - 400 mm
Backrest height	350 - 560 mm
Distance between armrest	adjustable
Backrest angle - adjustable	85° - 120°
Legrest angle - adjustable	85° - 170°
Battery capacity	2 x 60 Ah
Range (ISO 7176-4)	30 - 35 km
Maximum speed	7 km/h
Turning radius (ISO 7176-5)	610 mm
Obstacle height	70 mm
Suspension	yes
Electronics	R-net
Powered seat lift	option, 200 mm
Powered seat tilt	option, 0° - 45°
Powered legrest adjustment	no
Powered backrest adjustment	no
ISO 7176-19/ISO 10542-3	yes - crash tested
EN12182/EN12184 CE	yes

### FUNCTIONS

#### Electrical functions



Tilt adjustment



Seat lift

#### Colours



onyx black



volcano red



cobalt blue



deep purple

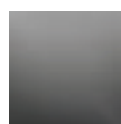

phantom grey



popstar pink

#### Upholstery



leatherette

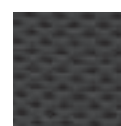

fabric

# Ready? Go!

## Playing on wheels

The **K300 PS Junior** enables children to join in all the fun. Its fully adjustable seat tray allows for the child's growth. The adjustable armrests, electric seat lift and tilt function, programmable R-net controls and the UniTrack system offer extra comfort. This electric wheelchair will withstand the odd knock or bump and is available in stylish and vibrant colours. Watch the video on our site!

### FEATURES

#### Seat

45° powered or manual seat tilt and 200 mm seat lift adjustment are available as an option.



#### Push handles

Push handles come as standard with the K300 PS Junior.



#### Control

R-net electronics: intelligent control system (ICS) with programmable settings.



#### Lighting

Optionally available with energy efficient front and rear LED lighting.



#### Legrests

Swing away legrests available.



#### Armrests

Easily-adjustable armrests for convenient adjustment of height, angle and width.



# K450 MX

 CRASH TESTED



## SPECIFICATIONS

Total length	1240 mm
Total width	640 mm
Minimum transport length	850 mm
Seat height	adjustable
Seat height with powered seat lift	100 - 655 mm
Total weight incl. batteries	112 kg
Maximum user weight	60 kg
Seat width	250 - 400 mm
Seat depth	250 - 450 mm
Backrest width	250 - 400 mm
Backrest height	325 - 425 mm
Distance between armrests	adjustable
Backrest angle	adjustable
Legrest angle - adjustable	90° - 180°
Battery capacity	2 x 60 Ah
Range (ISO 7176-4)	25 - 30 km
Maximum speed	8.5 km/h
Turning radius (ISO 7176-5)	1060 mm
Obstacle height	60 mm
Suspension	yes
Electronics	R-net
Powered seat lift	yes
Powered seat tilt	yes
Powered legrest adjustment	no
Powered backrest adjustment	no
ISO 7176-19/ISO 10542-3	yes - crash tested
EN12182/EN12184 CE	yes

## FUNCTIONS

### Electrical functions



Tilt adjustment



Seat lift

### Colours



onyx black



chili pepper red

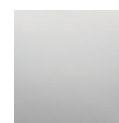

platinum silver



titan blue



popstar pink



xtreme yellow

### Upholstery



leatherette

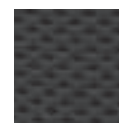

fabric

# New kid on the block.

## Unique functionality

With a suspension system on every wheel the **K450 MX** offers a smooth ride; whether going down the corridor at school or to the shops. The powered high/low setting makes it possible for children to get down to the ground. Perfect for listening to a story or switching to playing with others. The powered high/low setting ranges from 100 - 655 mm, making it easy to sit at a table or desk and even to reach down to things on the ground. In addition the K450 MX is equipped with R-net electronics with its numerous electrical options as standard, including powered high/low setting, seat-to-floor adjustment and optional powered seat tilt. The modular seating system has adjustable legrest attached in the centre and is supplied with a package for unrestricted growth, something every child needs. Larger seat dimensions are available; so this wheelchair is also extremely suitable for small adults.

### FEATURES

#### Controle

R-net electronics: intelligent control system (ICS) with programmable settings.



#### Seat tilt

Optional 45° powered seat tilt from any sitting position.



#### Legrest

Adjustable legrest.



#### Batteries

The batteries are easily accessible to allow optimal servicing.



#### Tyres

Optional leakproof tyres for improved performance and reduced maintenance.



#### Suspension

Suspension system on all wheels for better balance, improved ride and safety.





# Koala

MINIFLEX



## SPECIFICATIONS

Total length	965 mm
Total width	585 mm
Minimum transport length	710 mm
Seat height	340 mm
Seat height with powered seat lift	340 - 590 mm
Total weight incl. batteries	94 kg
Maximum user weight	35 kg
Seat width	250 - 300 - 350 mm
Seat depth	270 - 320 - 370 mm
Backrest width	270 - 320 - 370 mm
Backrest height	325 - 375 - 425 - 475 mm
Armrest height	250 - 350 mm
Backrest angle - adjustable	85° - 140°
Legrest angle - adjustable	90° - 150°
Battery capacity	2 x 40 Ah
Range (ISO 7176-4)	25 - 30 km
Maximum speed	6.5 km/h
Turning radius (ISO 7176-5)	570 mm
Obstacle height	60 mm
Suspension	no
Electronics	R-net
Powered seat lift	yes
Powered seat tilt	yes
Powered legrest adjustment	no
Powered backrest adjustment	no
EN12182/EN12184 CE	yes

## FUNCTIONS

### Electrical functions



Tilt adjustment



Seat lift

### Colours



apple green



lemonade yellow

### Upholstery



leatherette

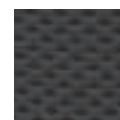

fabric

# Children's wheelchair.

The smallest wheelchair for kids

The **Koala Miniflex** is the ideal wheelchair for children, from toddlers to young teenagers. It is equipped with the same powerful motors and front-wheel drive as Permobil's wheelchairs for adults but adapted to the needs of children. The Miniflex seating system is a flexible seating system for growing children and children with special seating needs. Available in three sizes and with a range of body supports. Options include installation of an orthotic seat.

## FEATURES

### Control

R-net electronics: intelligent control system (ICS) with programmable settings.



### Wheel rims

Split rims with hubcaps.



### Charging point

Easily-accessible charging point.



### Seat

Equipped as standard with combined tilt and height adjustment.



### Rear wheels

Swivel rear wheels for responsive steering.



### Bumper

For safe and comfortable driving available as an option.







X850 CORPUS 3G

Outdoor.



# X850

CORPUS 3G



## SPECIFICATIONS

Total length	1260 - 1460 mm
Total width	720 mm
Minimum transport length	1260 mm
Seat height	540 mm
Seat height with powered seat lift	540 - 740 mm
Total weight incl. batteries	203 kg [batteries 2 x 31 kg]
Maximum user weight	136 kg
Seat width	420 - 570 mm
Seat depth	370 - 570 mm
Backrest width	360/410/460/510 mm
Backrest height	470, 545 - 670 mm
Distance between armrests	380 - 480/480 - 580 mm
Backrest angle - adjustable	120° manual - 150°/180° powered
Battery capacity	2 x 97 Ah
Range (ISO 7176-4)	35 - 45 km
Maximum speed	10 - 15 km/h
Turning radius (ISO 7176-5)	1680 mm
Turning in corridor	2250 mm
Obstacle height	110 mm
Electronics	Safegate
Manual legrest*	option
Powered seat lift	option, 200 mm
Powered seat tilt	option
Powered wheelbase	option
Powered backrest adjustment	option
Seat rotation	option - manual/powered
ISO 7176-19	yes - crash tested
EN12182/EN12184 CE	yes

## FUNCTIONS

### Electrical functions



Seat lift



Backrest adjustment



Tilt adjustment



Wheelbase adjustment



Seat rotation

### Colours



dark grey metallic



dark blue metallic



red metallic

### Upholstery



leatherette

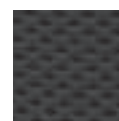

fabric

\*Legrest requires seat tilt. Legrest is not orderable together with seat rotation or extendable wheelbase.

# Built for outdoors.

Strong and fast

Our powerful offroad-wheelchair, the **X850 Corpus 3G**, doesn't just look sturdy, it's built for people who demand high performance. Do you need a strong wheelchair for use in the city or in the wild? Maybe you live some way away from the nearest shop or you go to work in your wheelchair or you want to join friends for a bike ride? You need a wheelchair that can cope and that you can rely on; the X850 Corpus 3G is the right choice. With rear-wheel drive, a powerful motor and robust suspension this is a wheelchair which you can safely drive at 15 km/hr. The seat of the X850 Corpus 3G can be rotated 180°, making mounting and dismounting easy. Other new features include directional lighting which stay on the track, spring-loaded mirrors, and rubber bumpers which can take a knock. Because we believe that safety always comes first, the X850 Corpus 3G is equipped with Electronic Steering Performance (ESP) which controls the engine and ensures that you never lose control when taking a corner. The servocontrol with joystick can be programmed to suit your wishes.

## FEATURES

Robust suspension on front and rear wheels	yes
Large wheel dimensions	yes
Strong rubber bumpers	yes
Easily programmable electronics	yes
Seat with many ergonomic options	yes
Armrest bag	yes
Directional lighting from headlamps	yes
Lockable control panel	yes
Transportation fastenings	yes
Manually or powered wheelbase adjustment	optional
Seat rotates in two directions	optional
Spring-loaded rear view mirror	optional
Easy-to-remove back box	optional
Easy-to-remove basket	optional
Roll holder	optional
Crutch holder	optional
Adjustable head support	optional
Thigh support	optional
Trunk support	optional
Four-point belt	optional
Belt with snap fastener	optional
Self-tensioning belt	optional
Long self-tensioning belt	optional
Guarantee	2 years

### Seating system

The Corpus seating system offers a range of power-adjusted options. For instance, you can use the control panel to easily adjust the backrest and leg rests. A powered seat lift is also available. The seat can be rotated 180° either by hand or electrically.



### Backrest

Electrically-operated backrest available.

### Wheelbase

Adjustable wheelbase ensuring the length is precisely suited to you and if necessary you can adjust the length of the chair.





LSR KID



LSR



LSA



LSE



LS

Lifestand.



# LS - LSE

 CRASH TESTED



LSE

LS

## SPECIFICATIONS

Total length when seated	890 - 1070 mm
Total length standing	940 - 1120 mm
Total width 3° camber	650 - 770 mm
Total width 0° camber	590 - 710 mm
Seat height	510 mm
Total height	840 - 1040 mm
Total weight	25 - 32 kg (LS - LSE)
Maximum user weight	120 kg
Seat width	360 - 400 - 440 - 480 mm
Seat depth	410 - 550 mm
Backrest height	320 - 400 - 520 mm
Battery capacity LSE	2 x 2.9 Ah
Rear wheel diameter	24/26 inch
Front wheel diameter	6 inch
Powered seat lift	no
Powered seat tilt	no
Powered legrest adjustment	no
Powered backrest adjustment	no
Manual stand-up function LS	yes
Powered stand-up function LSE	yes

## FUNCTIONS

### Get Vertical

Easily and comfortably assume a vertical position in this conveniently transportable wheelchair.



### Colours

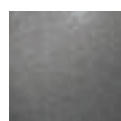

silver



deep blue



black



electric red

### Upholstery

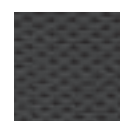

fabric

# Get Vertical.

Upright without strain

The **LS** and **LSE** are ideal for users who want to stand upright but cannot do this by themselves. The LS offers the user help to stand up with the aid of two gas-spring cylinders and the LSE raises the user to a vertical standing position by means of an electric motor. Both chairs are constructed of innovative, lightweight material. Armrests, knee supports and a chest strap guarantee safety, comfort and stability. To optimise manoeuvrability the centre point of the rear axle can be easily adjusted in relation to the frame. In addition the possibility of standing upright offers many benefits for health: including improved control of the muscles, stronger bones, improved blood circulation and a reduction in spasms. With the LS and LSE you can easily take part in day-to-day activities with family, friends and colleagues. Comfort and independence at a stroke!

## FEATURES

### Armrests

Robust, fold-away armrests offer stability and ensure easy transfers.



### Footrest option 1

Swing away, one-piece, flip up footrest.



### Backrest

Patented backrest angle adjustment for good positioning of the upper body.



### Footrest option 2

Footrests with adjustable height and angle for optimal fit and comfort.



### Knee supports

Safe, swing-away knee supports.



### Footrest option 3

Swing away, dual, flip up footrests.



### Motor

The electric motor easily brings the LSE chair into a vertical position.



### Rear axle

Adjustable rear axle for optimal manoeuvrability.





## SPECIFICATIONS

Total length when seated	890 - 1010 mm
Total length standing	930 - 1050 mm
Total width 3° camber	660 - 760 mm
Total width 0° camber	600 - 700 mm
Seat height	510 mm
Total height	780 - 910 mm
Total weight	16 kg
Maximum user weight	100 kg
Seat width	360 - 380 - 400 - 420 - 440 - 460 mm
Seat depth	430 - 530 mm
Backrest height	320 - 460 mm
Rear wheel diameter	24/26 inch
Front wheel diameter	5/6 inch
Powered seat lift	no
Powered seat tilt	no
Powered legrest adjustment	no
Powered backrest adjustment	no
Manual stand-up function	yes

## FUNCTIONS

### Get Vertical

Easily and comfortably assume a vertical position in this high-tech and lightweight wheelchair.



### Colours



arctic white    chrome    deep blue    black    wine red

### Upholstery



fabric

# Get Vertical.

## The lightest stand-up wheelchair

The **LSA Helium** has been designed for active indoor and outdoor use. The lightest stand-up wheelchair in the world is made of featherlight advanced aircraft aluminium and titanium. In combination with gas-springs it ensures an ergonomic, simple and safe stand-up system. The patented angled backrest system and the adjustable seat depth guarantee a comfortable seat. Stable knee supports in foam padding and Neoprene plus an adjustable chest strap provide a sense of safety and comfort in a vertical position. The LSA Helium offers independence and comfort, and puts you at eye-level with the people around you. In addition the possibility of standing upright with the LSA also offers many benefits for health: improved control of the muscles, stronger bones, improved blood circulation and a reduction in spasms, to mention a few.

### FEATURES

#### Backrest

Patented backrest angle adjustment for good positioning of the upper body.



#### Armrests

Safe, swing-away armrests for easy transfers (optional).



#### Seat

Hard-wearing and adjustable chair upholstery.



#### Wheelchair

The lightest stand-up wheelchair in the world, weighing just 16 kg.



#### Transport

Easily taken apart for transportation.



#### Rear axle

Adjustable rear axle for optimal manoeuvrability.



#### Footrests

Footrests with adjustable height and angle for optimal fit and comfort.







## SPECIFICATIONS

Total length when seated	940 - 1060 mm
Total length standing	990 - 1110 mm
Total width 0° camber	580 - 700 mm
Seat height	510 mm
Total height	840 - 920 - 1040 mm
Total weight incl. batteries	30 kg
Maximum user weight	120 kg
Seat width	360 - 400 - 440 - 480 mm
Seat depth	410 - 550 mm
Backrest height	320 - 400 - 520 mm
Battery capacity	2 x 2 Ah
Rear wheel diameter	24/26 inch
Front wheel diameter	6 inch
Powered seat lift	no
Powered seat tilt	no
Powered legrest adjustment	yes
Powered backrest adjustment	yes
Powered stand-up function	yes
ISO 7176-19	yes - crash tested

## FUNCTIONS

### Get Vertical

Easily and comfortably assume a vertical position using the one touch-function in this conveniently transportable wheelchair.



### Colours



arctic white



deep blue



black



electric red

### Upholstery



fabric



# Get Vertical.

## Stand up and relax functions

The **LSR** combines design with outstanding functionality. As well as a stand-up function the LSR also offers a relax function using an electric motor. The LSR is ergonomically-friendly and made of innovative, lightweight material. The ability to stand with the LSR also offers many medical benefits. Besides improved control of the muscles, stronger bones and improved blood circulation it can prevent bedsores. And there is of course a socio-psychological advantage in being able to communicate at eye-level with other people. With the LSR you can easily take part in day-to-day activities with family, friends and colleagues. Comfort and independence at a stroke!



### FEATURES

#### Relax function

Manual wheelchair with a sleek design, the LSR offers a power standing feature and an exclusive recline feature as well.



#### Control

One-touch powered relax function.

#### Knee supports

Safe, swing-away knee supports.



#### Footrests

Fully-adjustable footrests.



#### Armrests

Fold-away, rotatable armrests.



#### Transport

Fold-down backrest for easy transport.



# LSR KID



## SPECIFICATIONS

Total length when seated	900 - 1020 mm
Total length standing	935 - 1055 mm
Total width 0° camber	535 - 595 mm
Total width 6° camber	566 - 626 mm
Seat height	380 mm
Total height without headrest	900 mm
Total weight incl. batteries	22 kg
Maximum user weight	50 kg
Seat width	280 - 300 - 320 - 340 mm
Seat depth	240 - 360 mm
Backrest height	260 - 420 mm
Battery capacity	2 x 2 Ah
Rear wheel diameter	20/22 inch
Front wheel diameter	4/5 inch
Powered seat lift	no
Powered seat tilt	no
Powered legrest adjustment	yes
Powered backrest adjustment	yes

## FUNCTIONS

### Get Vertical

Glide your way smoothly and easily to a comfortable and secure standing position in this attractive and transportable stand-up wheelchair.



### Colours



blue pop



red pop



yellow



pink

### Upholstery



fabric

# Get Vertical.

## Stand up and relax functions

The **LSR KID** is a concentrate of ingenuity dedicated to active children and of course their parents, often called upon. The LSR Kid is a manual wheelchair for children with a standing function as well as a relax one, both electric and therefore very easy to use. This product has been conceived at the request of parents who wanted to see their kids evolve in a chair which could stimulate their mobility while providing them maximum autonomy. Indeed, the LSR Kid safely makes it possible for the kid to stand up for more autonomy, or lay down in the relax position in order to limit the number of transfers. Participate in class, play video games; it is now possible in the most independent way!



### FEATURES

#### Relax function

Power standing feature and an exclusive recline feature as well.



#### Control

One-touch power standing & recline functions.

#### Functionality

Safe standing thanks to a set of detectors.



#### Adjustability

The chair grows with your kid thanks to clever adjustment systems.



#### Transport

Easy to carry.



#### Armrests

Multi-directional armrests.



**TiLite** has the world's most innovative and user-focused range of active wheelchairs. The company designs and manufactures ultra-lightweight manual wheelchairs in titanium or aluminum that can be customized to each user's exact specification.

## New brand within Permobil Group.

**TiLite** has been around for close to three decades. We just didn't make wheelchairs in the early years. Back then we made titanium bike frames, golf shafts, motorcycle frames, and a huge variety of custom, one-off titanium projects. We also made titanium wheelchair parts for a few wheelchair manufacturers. Then, in the late 1990's, we began to wonder whether it would make sense to apply our knowledge of customization to wheelchairs. In other words, would a wheelchair frame that is fabricated to fit a single person make it perform better for that person? We knew it would fit better and be more comfortable, but would this ergonomic improvement make it easier to push? It turns out that it would. We now call this process TiFit. And what about aesthetics? Many of our bike and motorcycle customers demanded well-built products that looked beautiful too. What if we applied the same attitude toward wheelchairs? And what would a wheelchair look like if we placed demands on ourselves to make our custom wheelchairs look beautiful? The first customized and beautiful TiLite wheelchair came to life in 1998 as the CrossSport. Redesigned to be lighter and better looking three times since then, we now call it the TR, our flagship chair. Our mission today is simple: Make the best fitting, best performing, and best looking wheelchairs in the world. We put our hearts and souls into it, and that's one thing that will never change.







'TiLite shares our culture of excellence and commitment to delivering an outstanding wheelchair experience to our users'

Larry Jackson - President of Permobil North America





ACCESSORIES



CONTROL



COMFORT



MOBILITY



CUSTOMIZATION

Solutions.

# Made for you.

For us - creating solutions for individuals through customization is natural. With many years of individual adaptations we have developed great experience and innovative solutions. At Permobil there are no standard chairs. Every wheelchair is produced with you in mind and based on your measurements, your demands and your requirements – either through our large assortment of accessories and configurations or through innovative customized solutions.



## Customization and adaptation.

### **Tailor made to your needs and requirements**

We strive to create a solution that takes all the needs and requirements of the user into consideration, either through individual configurations or customization. Configurations are adjustments to default settings or the use of some of our standards accessories while customizations are defined as new, individual solutions. Permobil produces and delivers over 5.000 customized wheelchairs each year. Our individual configurations and customization are always made in close cooperation with the user, the therapist and our Permobil consultant – the result, a highly individualized wheelchair fulfilling requirements and in accordance with local regulations applicable for medical devices.

### **Your demands - our challenge**

Virtually anything is possible for our technicians. We take pride in developing new solutions. Our objective is to create a customized wheelchair with the same design, functionality and performance as our standard chair. The requirements might be small, like a cup holder or complicated, like a specially adopted vertical standing chair. Nothing is too grand or too small, anything to make the wheelchair as functional and comfortable as possible.



EXAMPLES OF CUSTOMIZATION

**Molded seat**

We have long experience in installing special seats from other suppliers on our chairs and chassis. In the pictures you see a custom molded seat. On the same chair we also made a respirator tray that will follow the seat position. The tray will adjust itself automatically when the seat is tilted, the respirator is always in a horizontal position.



**Electrical armrest**

This feature was designed to ease and train the movement in the shoulder joints. The user was also able to continue with her hobby, which is playing flute.

**Custom paint**

We can supply the wheelchairs with special upholstery (padding, stitching) and custom paint on request.





# Mobility.

An electric wheelchair is a friend that will take you anywhere you want to go. The better the wheelchair suits the circumstances, the more freedom of movement you will be able to enjoy. Permobil electric wheelchairs have powerful motors, long-lasting batteries, independent suspension, a tight turning radius and excellent driving characteristics.







# Enhanced Steering Performance.

Enhanced Steering Performance (ESP) is the active driving safety system for stable, controlled and safe driving. Permobil has fine-tuned its ESP system for over 10 years, ensuring that all drivers benefit by safely and accurately steering their power wheelchairs over any type of terrain whether indoors or out with minimal effort. It enables drivers to easily navigate sloped or angled areas, rough surfaces, carpeted floors and more without worrying about their wheelchairs gently drifting or even abruptly changing direction. Drivers can also safely travel at high speeds without the fear of spinning out of control. ESP prevents all of the unwanted driving responses and steering corrections that can be challenging and tiresome, all the while keeping drivers secure and on track.





### Benefits to the driver

- ESP is the standard of practice for non-proportional and switch drivers.
- ESP virtually eliminates the need for constant manual correction, making it imperative for non-proportional drivers, while significantly helping proportional drivers with minimal hand strength and endurance.
- For users with high-speed chairs ESP gives them the stability to avoid spin-outs.

### ESP and R-net

When ESP is installed on a wheelchair with R-net drive electronics, the speed settings can easily be adjusted using On-Board Programming without having to remove the shroud or connect to a computer.

### Terrains and surfaces

- ESP excels when it comes to angled and sloped areas, ensuring the wheelchair maintains the direction of the driver's command with virtually no correction.
- Rough and soft surfaces are no longer a problem with ESP.
- Surface variations typical on hard floors and carpets force a driver to make constant corrections to stay on track, particularly when navigating passages. ESP eliminates these barriers.



### Gyroscope vs. Encoder Technology

Unlike other wheelchair companies, Permobility utilizes gyroscopes for its steering technology, rather than encoders. With gyroscopes, the ESP system is constantly monitoring the actual direction of the wheelchair, comparing this to the driver's requested direction, and automatically making corrections to stay on track. ESP uses Memorized Directional Intelligence™ (MDI) that does not rely on drive wheel speed as encoder based systems do, which means a wheelchair with ESP will not lose its direction due to a loss of traction. For example, when a wheelchair traverses bumps or slippery surfaces, the ESP system will remember the original direction and automatically keep the chair on course. This is not possible with encoder systems that require constant traction to stay on course.



# Flat-free tyres.

## Two-piece rims

Our Flat-free tyres come as a complete package in combination with our two-piece rims, so no need to worry that changing a tyre will be difficult. This unique combination makes service extremely easy!



## The most innovative wheelchair tyre

With the Permobil Flat-Free Tyres you can enjoy a smooth, comfortable ride with little or no change in chair performance. Unlike the foam in other solid tyres, the highly innovative Flat-free tyres developed exclusively for Permobil are filled with a special two-component gel-rubber. This two-component material enables better contact with the ground, giving a better grip. The tyre adjusts itself, you might say, even if you ride over obstacles. Unlike other solid tyres, Permobil Flat-free tyres will not deform with use. You'll feel like you're floating on air!

ISO 7176-19 / ISO 10542-3  
EN12182 / EN12184



LOAD RANGE B TUBE TYPE  
4 P.S.I. MAX. INFLATE TO 50 P.S.I.

permobil

8  
-00  
LH-51  
00  
88



# Permolock.

## The road to independence

Both Permolock devices allow you to drive or ride while sitting in your Permobil wheelchair. These devices secure your wheelchair inside the vehicle and are designed for use with the different Permobil wheelchair bases. You can adjust both the angle and height of the Permolock devices, which help when mounting them in a vehicle with a sloped driver's position. A locking device mounted to the wheelchair chassis and a locking plate that is mounted to the vehicle ensure the wheelchair will not break free in the event of a collision or other sudden movement. In addition, you can pull either forwards or backwards into the locking plate.

### FEATURES



#### Locking Plate

An easy-to-install docking station that holds the chair firmly and securely in position.

#### Control button armrest

Located on the armrest, the control button is used to drop the locking pin into place, so it can properly dock to the locking plate.



#### Manual release

Wheelchair can be released manually in the event of vehicle power failure.



#### Control button vehicle

Located on the dash, it has three lights, -red, amber and green, to indicate if the chair is locked into place. Simply press and hold to unlock the wheelchair.





CE

PERMOLOCK C3

**Designed for**

C300, C350, M400, K300 and F5 power wheelchairs.



**Locking pins**

When activated, the retractable locking pins drop into place to secure the wheelchair. When not in use, the pins retract for maximum ground clearance.



**Emergency release**

Locking mechanism can be opened manually with the emergency handle on the front edge of the locking plate.



**Adjustable base**

The height of the base can be adjusted in 5mm increments, and the angle adjustment utilizes a spring to help mount it on a slope.



**Installation spacer**

Used to install Permolock C3 on a sloping surface.



PERMOLOCK C

**Designed for**

Permolock C is designed only for use with the C400 and C500 power wheelchairs.

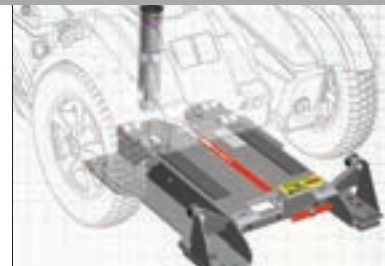

**Locking pin**

When activated, the retractable locking pin drops into place to secure the wheelchair. When not in use, the pin retracts for maximum ground clearance.

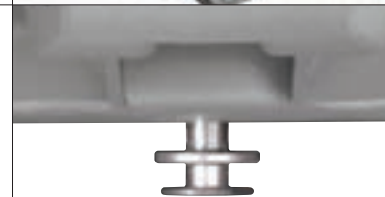

**Emergency release**

Locking mechanism can be opened manually with the emergency handle on the front edge of the locking plate.



**Car seat adapter**

Permits use of original car seat in Permolock C.



**Installation spacer**

Used to install Permolock C on a sloping surface.



# Comfort.

Many have one chair only, which serves as a dining chair, armchair, kitchen chair, desk chair, travel chair, car seat and sofa bed. The more adjustable the wheelchair is, the better it can serve all these purposes. An easily adjustable powered wheelchair is also healthier because it enables you to adjust your posture yourself according to the circumstances and the requirements of your own body.









# Ergo seat.

## FEATURES

### Electrical functions



Tilt adjustment



Seat lift



Leg rest adjustment



Backrest adjustment

### Armrests

Rotating armrests for comfortable support when sitting.



### Cable system

Integrated cable system prevents cable damage.

### Comfort

The Corpus is stylish and elegant, and has all the comfort and feel of the original Corpus seating system.



### Upholstery



leatherette



fabric



# The dawn of a new day.

## Adjustability and ergonomics

Many thought it was impossible to improve the Corpus seating system. But once again, Permobil shows its determination to strive for perfection. Permobil's last version of Corpus has been developed in collaboration with the original world-renowned designer of the Corpus, the Swedish ergonomics expert Bengt Engström. The design makes use of the blueprint of Engström's concept of interactive counterpressure. It incorporates state-of-the-art ergonomic design, as well as electrical and mechanical technology, to create a powerful seating system unifying form and function.

### Backrest

Divided backrest, adjustable in steps of 25 mm.



### Head support

Unitrack rail at the top of the backrest for lateral adjustment.



### Backrest adjustment

Powered backrest adjustable up to 175°. Biomechanical option.



### Seat tilt

50° seat tilt as standard option. Very important support when prevention of pressure sores is the issue.



### Legrest

Curved legrest for a natural sitting posture.



### Armrests

Flip-up armrests are ideal for sideways transfers.





# Corpus Ergo Air.

With ROHO Technology

Permobil Corpus Ergo Air. ROHO and Permobil have joined together to evolve Permobil's Corpus positioning cushion to feature an optional ROHO insert for added comfort, support, and skin protection. The cushion combines the shape matching ability of the ROHO Dry Floatation® technology with Permobil's ergonomic design. The improved cushion design enhances the already revolutionary Corpus seating system, providing you with the superior skin protection that ROHO is known for. This new cushion allows for improved pelvic alignment and stability while maintaining optimal support of both the ischial tuberosities and greater trochanters.



### Positioning and safety

Our ergonomic positioning cushion is contoured to provide pelvic stability and improved lower extremity alignment. The lateral edges of the cushion accommodate removable seat wedges and help provide control in the seated position. Overall, the system is designed to improve comfort and positioning while minimizing tissue deformation.

### Skin protection

The specially-designed ROHO insert supports the ischial tuberosities and the posterior shelf of the greater trochanters for those clients who are at high risk of breakdown. It provides an adjustable, reduced friction and shear environment that can help protect the client from acquiring pressure ulcers from sitting.

### Adaptive comfort

Along with exceptional skin protection, the ROHO insert provides personalized comfort. By adjusting the amount of air, the cushion can be tuned to match the individual's shape. Cleaning requires just soap and water, and the specially designed cushion cover is also machine washable for added convenience.

#### Skin protection

Designed for proper immersion and envelopment of the pelvis for soft tissue protection.



#### Air-valve

Adjustable air-valve allows for easy inflation or deflation with hand pump for individual comfort.



#### Support

Ergonomically designed cushion includes space for Corpus lateral wedges to enhance positioning.



#### Tailor made

Available sizes range from 430 - 530 mm wide and 430 - 530 mm deep for the perfect fit.



#### Abductor

Cushion design includes a center pommel for improved positioning of the lower extremities.



#### Stretch cover

The removable stretch cover is designed to aid in the skin-protecting qualities of the ROHO insert.



# Body support.

Simplicity by Design

The UniTrack system from Permobil combines a number of modular elements which together offer you a made-to-measure fit for optimal body support. Simply select the right support and the appropriate adjustable joint and fit them where required. The system is infinitely adaptable and adjustable. Only a half-turn of the rapid release handle is needed to remove the support. There are no protrusions on the handle so it will not catch on anything. The UniTrack system is exclusively designed for the Corpus seating system.



## Support cushions

Support cushions are available in many shapes and styles, with breathable upholstery for extra comfort. Depending on your requirements, the supports are interchangeable and can be used as thigh support cushions or calf support cushions.





### Adjustable joints

These can be used to rotate the supports and lock them in the right place. Adjustments are graduated so as to allow an endless variety of settings.



### Stump support

For support of an artificial leg. Easy to adjust height, depth, angle and width. Simple to remove by just a half-turn on the handle.



### Lateral supports

For lateral support of the trunk. Easy to adjust height, depth and width. Also easy to rotate away to either side.



### Calf supports

The calf supports can be rotated 360° using rails. Height, depth, width and angle are also adjustable.





# Control.

A robust, manoeuvrable and comfortable wheelchair with lots of customised settings. That's all very well but of no use at all if you can't control it. And by controlling it, we don't just mean steering it from A to B but also using all the electronic aids and the many seat settings. At Permobil we do our utmost to ensure our wheelchairs have as logical a dashboard as possible. It is our philosophy that we apply state of the art technology to make our users' lives as pleasant as possible.







# MagicDrive Touch.



## Control system

Problems are there to be solved. That is the thought behind our alternative control system MagicDrive Touch. Whatever your disability, you will be able to control the wheelchair easily and actively whilst maintaining direct control of your environment and communication with others in everyday life. The MagicDrive Touch is so flexible that most problems can be solved. A nod of the head or the slightest finger movement can be all it takes to operate the wheelchair. For example, contact by means of telephone, digital media or modern speech technology is also possible with the MagicDrive Touch. In practice, this means that the MagicDrive Touch can be adapted to your individual needs. Every wheelchair is personalised. The key is to use advanced technology to enable what used to be impossible. MagicDrive Touch can make the difference between doing something yourself or having to ask for help.

# Advantages.



## Integrated

A single integrated operating system enables you not only to independently control your wheelchair yourself, it also enables you to operate your communication and other equipment in your environment efficiently, using the same display for everything.



## Flexible

Available on wheelchairs for both adults and children.



## Plug & Play

Thanks to the plug & play system, any adaptations and/or control changes can be effected quickly and easily. The system consequently doesn't need to be replaced.



## Controls

The wide range of special controls, including joysticks, mini-joysticks, finger joysticks and scanning offers everyone a suitable solution to operate the MagicDrive Touch.



## Graphic screen

The graphic screen of the MagicDrive Touch can also be used separately, without the wheelchair (stand-alone). This means you no longer need to buy a second system.



## Customization

Easy, flexible configuration (set-up) enables you to customise the MagicDrive Touch to suit your personal requirements.



## Easy to operate

Easy to operate thanks to a clear display with text, icons or speech and a well-thought-out menu structure. Available in eleven languages.



## Infrared

Several standard codes have already been programmed into the built-in infrared transmitter, enabling the remote control of a computer mouse, telephone and switches, etc.



## Standard infrared

The standard built-in infrared transmitter can learn infrared codes from existing remote controls. So you will be able to operate much of the equipment in your environment straight away.



## Options

Its range of optional modules makes the MagicDrive Touch the most complete system on the market.



## Re-usable

Re-usable thanks to standard and comprehensive installation package.



## Simple programming

The settings can easily be adjusted by the user, their attendant or the dealer.

# Environment and communication.



## Environment

MagicDrive Touch opens more than doors! Of course you can use the MagicDrive Touch to open doors, but you can also use it to operate the radio, TV, lights, computer and tablet. Your safety has also not been forgotten: the MagicDrive Touch can be connected to an alarm or intercom system. The MagicDrive Touch incorporates infrared and Zwave (radio wave) environmental controls, offering you all the flexibility you require to operate equipment in your environment. To use the infrared control you can select a code from the pre-installed library or install a new code yourself. For Zwave controls you can programme and manage the network on the MagicDrive Touch yourself. As you programme the menu yourself it makes operating your environmental equipment easy and clear. E.g: programming controls per room (kitchen, lounge, bedroom) or per product group: one button to switch all the lights off.

## Communication

The MagicDrive Touch uses state of the art technology to enable you to control your environment the way you want to. The record function enables you to record sound which can then be used as short spoken messages or acoustic feedback. You can operate the MagicDrive Touch with the touch screen, the joystick on your wheelchair, buttons, a USB keypad, etc. The mobile phone solution guarantees the reliability of this function in the event of an emergency. Then TTS (text to speech) functionality enables you to call someone and to 'speak' to him/her even if you cannot use your own voice.

## Features

- Various operating options: touch screen, buttons, wheelchair controls.
- Stand Alone use possible thanks to high performance Lithium-ion battery capacity.
- Customisable background.
- Adjustable button size: small, medium or large.
- Learn the infrared codes and operate your equipment.
- Select your own personal menu structure.
- Connect USB appliances such as a flash disk, USB-mouse etc.
- Manage details of your contact persons.
- Control your environment using Z-wave technology.
- Record sound and voices to use later.
- TTS feedback (text to speech); screen displays your position.
- TTS messenger; whatever you type is spoken.
- Media player; plays music and videos and displays photos.
- Different voices, depending on the language you select.
- Make telephone calls using an IR-telephone or the integrated mobile phone function.
- Available in 11 languages: English, French, German, Dutch, Italian, Spanish, Portuguese, Norwegian, Swedish, Danish and Finnish.

## Set-up Standard configuration

- MDT 400 (infrared, Z-wave, diary, contact management, calculator, colour touch screen, battery, 4GB main storage, USB connection, headphone connection, internal speaker).
- MDT 420 (MDT 400 including mobile phone).

## Options

- Media tool
- Text To Speech feedback (TTS)
- TTS messenger
- TTS language selection

## Accessories

- Easy phone
- Easy mouse
- Bluetooth mouse
- 6-channel module
- Hand heater
- IR receiver





Garage door



Stereo



Coffee machine



Oven



Plug socket



Computer

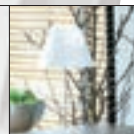

Light



Gas fire



TV - Video



Roll-down shutter



Easy Output Hand transmitter



Door opener



IR Phone



Bed



Mobile phone



Intercom



# Controls.

## Compact joystick advanced

All functions are controlled by the joystick.



## Compact joystick

All functions are controlled by the joystick. Also available as an ultra-light, more sensitive joystick.



## Heavy duty joystick

Specially designed to resist higher pressure. All functions are controlled by the joystick.



## Compact joystick chin control



## Mini-joystick

Minimal movement of the finger or chin is sufficient to operate the wheelchair.



## Remote stop

Range, with a clear field up to 30 meters.



## Finger control

Works like a joystick and is operated by the slightest movement of the finger.



## Table control

Swing away table, left or right.



## Head controls

The Head Array enables the user to operate the wheelchair by head movements.



## Joystick foot controls



# Switches.



**Scan select Switch**



**Touch Switch**

**Switch on a Swan-neck**



**Buddy Button**



**Grasp Switch**



**Mini Cup Switch**



**Cup Switch**



**Micro Light Switch**



**Hand Heater**

The hand heater produces a constant warm flow of air that warms the hand.



**Multi Switch Control**

1, 2, 3, 4 or 5 external switches can be connected as drive or control buttons.



# Co-Pilot.



## Almost invisible

When operating a wheelchair it is important to companions that the chair is easy to control. Permobil's Co-pilot for wheelchairs that are operated by companions works quite differently to earlier versions of companion control. The major advantage of the Co-pilot is that it requires hardly any muscle strength and control of the wheelchair is extremely intuitive; as simple as guiding a pushchair. The control system responds immediately when the speed or direction change. The Co-pilot also has the unique function that the companion can control the chair functions and speed.

## Ergonomics

The height and angle of the ergonomic grip can be adjusted for greater ease of use by the companion.



## Control Bar

Take a firm grip of the control bar and the wheelchair starts to move in the desired direction. Push slightly to the right and the chair moves easily to the right. As you walk faster, the chair's speed also increases. The responsive control makes driving the chair safer and easier both for the companion and for the wheelchair user.

## Handles

The ergonomic grip can be neatly folded away when not in use.





# Permofix.



## Connecting parts

Permofix is a modular, easy-to-configure assembly system for joysticks, screens, switches, etc. Rods (A) can be fastened to joints at any angle simply by tightening a bolt (B). And they are just as easy to remove. The rods can be inserted in the joints and removed again, enabling adjustment at any time. The system allows elements to be fixed at any angle. Combining basic components forms various modules. These modules make it possible to assemble elements in a simple, efficient and flexible way. The modularity of Permofix provides endless combinations and solutions. Special parts allow Permofix to be used in combination with other systems or with standard parts. Especially where fine-tuning is needed, Permofix is the ideal solution.



Permofix armrest fitting with mini-joystick.

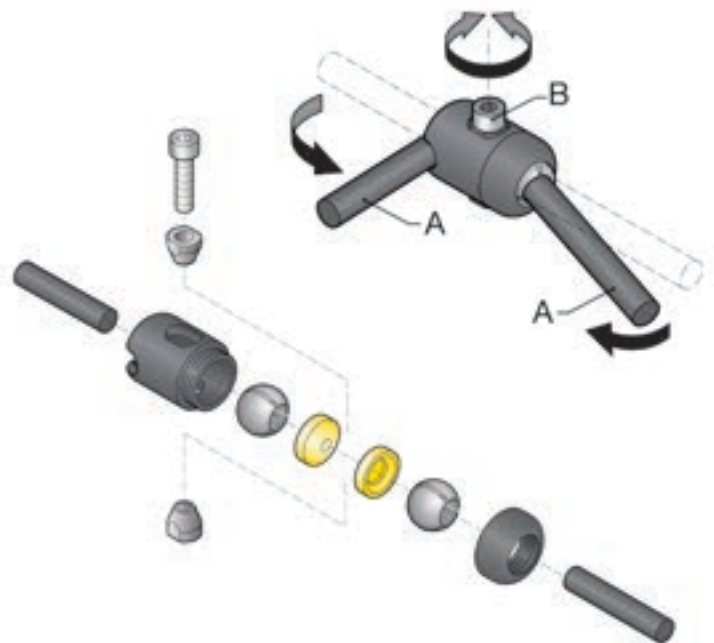

# Accessories.

## Smart equipment

To increase the ease of use of your electric wheelchair, Permobil has assembled a varied range of accessories. Permobil's special accessories ensure that the user and his/her companion can enjoy life even more. Permobil's varied selection of accessories optimally equips you to carry out your daily activities. The smart accessories from Permobil complement your electric wheelchair.



Tarpaulin

### Transfer handles



### Inflatable lumbar support



### Abduction wedge



### Foot straps



### Incontinence cover



### Push handles





Headrests

Joystick handles



Belts



Elbow support



Comfort plus headrest



Armrest gel pad



Lateral support





# Accessories.



Luggage carrier

Back box



Holders phone and tablet



Backpack



Bag hooks



Remote stop





**Crutch holder**



**Oxygen holder**



**Table**

**College table**



**Tilttable table**



**Cup holder**



**Swing away table**

Swing away to left or right.  
with right or left controls.



**Swing away table**

Swing away to left or  
right with central controls.



## SWEDEN

### Head Office Permobil AB

Per Uddéns väg 20  
Box 120  
861 23 Timrå  
www.permobil.com  
Tlf. +46 (0)60595900  
Faks +46 (0)60575250

## GREAT BRITAIN

### Permobil Ltd.

Oceanic Ground floor  
Navigation Business Park  
Waters Meeting Road  
Bolton  
BL1 8SW

Tel. +44 (0)1484 722888  
Fax +44 (0)1484 723013  
info@permobil.co.uk

## BENELUX

### Permobil Benelux BV

Brandenburger Strasse 2 - 6  
40880 Ratingen  
Germany  
info@permobil.nl

## CHINA

### Permobil (Kunshan) Co., Ltd.

No. 7 Workshop, Ruian Road,  
Shipai Area Swedish Industrial Park  
Bacheng Town Kunshan  
Tel. +86 (0)512 86188050  
Fax +86 (0)512 86188052  
sales@permobil.cn

## GERMANY (New adress from June 1st. Check our website.)

### Permobil GmbH

Head Office Germany  
Brandenburger Strasse 2 - 6  
40880 Ratingen, Germany  
Tel. +49 (0)231 945 36 30  
Fax +49 (0)231 945 363 20  
info@permobil.de

### Service Center Nord-Ost

Ahornallee 8  
14552 Michendorf  
Tel. +49 (0)33205 23975  
Fax +49 (0)33205 23973

## DENMARK

### Permobil AS

Måløv Værkstedby 59  
DK-2760 Måløv  
Tel. +45 (0)44 68 14 06  
dk@permobil.com

## SWITZERLAND (New adress from June 1st. Check our website.)

### Permobil AG

Industriestrasse 4  
CH-6055 Alpnach Dorf  
Tel. +41 (0)41 672 76 00  
Fax +41 (0)41 672 76 09  
info@permobil.ch

## NORWAY

### Permobil AS

Industriveien 16  
1481 Hagan, Norway  
Box 60  
1483 Skytta

Tlf. +47 (0)815 30 077  
Faks +47 (0)67 07 99 59  
ks@permobil.com

## FRANCE

### Permobil France SAS

5 Rue Clément Ader  
FR-69740 Genas  
Tel. +33 (0)437 26 27 28  
Fax +33 (0)437 26 27 29  
info@permobil.fr

## DISCLAIMER

Permobil pays every possible care and attention to the facts and figures given in this brochure. Nevertheless there may still be errors and/or omissions. Permobil accepts no liability for losses resulting from these errors and/or omissions, or for problems caused by the use or distribution of these facts and figures. Permobil likewise accepts no liability for actual loss, lost profit or lost enjoyment of life arising from the use or distribution of the information, or arising from technical defects. User data gathered by Permobil is processed and stored in accordance with European data privacy legislation. For more information see our website.



visit us on [permobil.com](https://permobil.com)