

# allard<sup>USA</sup>



## **COMBO™** **... The Perfect Combination**

World's Leading Carbon Composite AFO Technology  
with Carbon Graphite Hyperextension Knee Orthosis!

### **COMBO**

- Anatomically Shaped Thigh Cuff
- Dual Axis Joints
- Popliteal Interface for Knee Extension Control
- Shapeable Stainless Steel Uprights
- Pre-contoured, yet Shapeable ToeOFF or BlueROCKER Connector



### **ToeOFF® or BlueROCKER™**

The Original Dynamic Response Floor  
Reaction Carbon Composite AFO

**Custom Fabricate**  
a Super-Lightweight KAFO  
**in Your Own Facility!**

[www.allardusa.com](http://www.allardusa.com)

# COMBO™

a ToeOFF® Family product

## TRACE

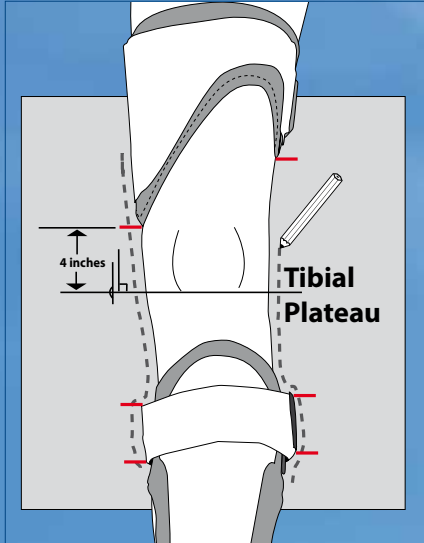

## SHAPE

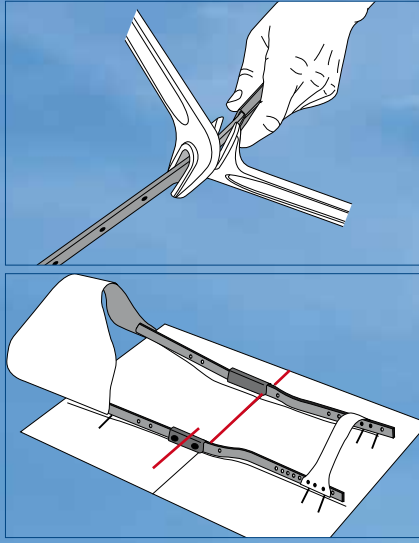

An Orthotist or Technician highly skilled in shaping metal KAFO uprights is required to fabricate the Perfect Combination.

## FABRICATE

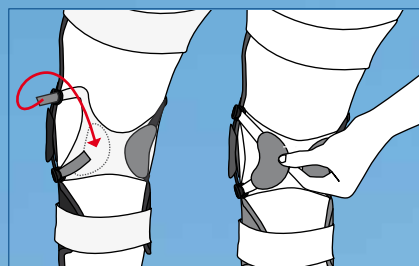
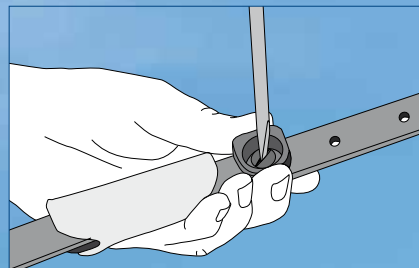
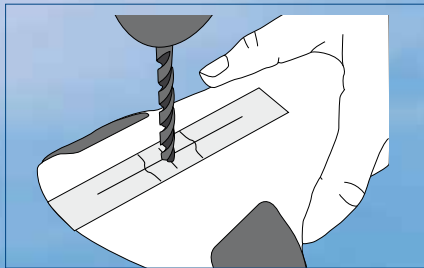
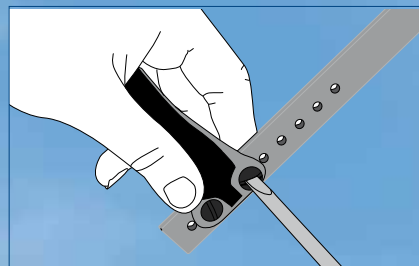
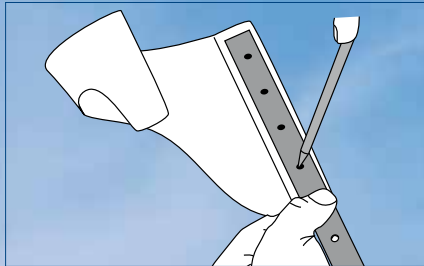

# FABRICATE A CUSTOM KAFO!

## (Just 5 Components + ToeOFF or BlueROCKER)

NOTE: Different sizes of the components can be combined to accommodate individual patient needs.

### 1 JOINTSWITH UPRIGHTS

Item No.	Size
28780 0000	One Size

### 2 TIBIA CONNECTOR

Generally, select the same size as the ToeOFF or BlueROCKER. However, the next smaller size will “snug” the wings of the ToeOFF or BlueROCKER closer to the leg for the extra small calf, and the next larger size may better accommodate a larger calf.

Item No.	Size
28784 0011	Small
28784 0012	Medium
28784 0013	Large/X-Large

### 3 KNEE CONTROL COMPONENT WITH POPLITEAL INTERFACE

Take a M-L (knee width) measurement.

Item No.	Size	Medial-Lateral
28782 0011	Small	2 3/4 - 4 1/4 in
28782 0012	Medium	3 3/4 - 5 1/4 in
28782 0013	Large	5 - 6 1/4 in.

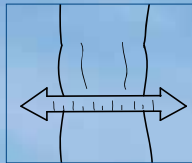

### 4 THIGH CUFF

Take a circumferential measurement at height where thigh cuff is to be located, however, make certain it is NOT LESS than 4” (10 cm) above the tibial plateau. Take a M-L measurement at same height.

Item No. Left	Item No. Right	Size	Circumference	M - L
28781 1011	28781 2011	Small	11 3/4 - 15 3/4 in	4 1/4 - 6 in
28781 1012	28781 2012	Medium	15 - 19 3/4 in	5 1/4 - 6 in
28781 1013	28781 2013	Large	19 - 23 3/4 in	6 - 7 1/2 in
28781 1014	28781 2014	X-Large	22 3/4 - 27 1/2 in	6 3/4 - 8 1/4 in

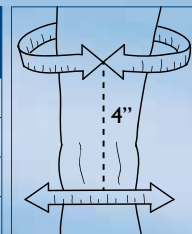

### 5 THIGH CUFF SOFTKIT

Same size as Thigh Cuff.

Item No.	Size
28783 0011	Small
28783 0012	Medium
28783 0013	Large
28783 0014	X-Large

**COMBO™**  
a ToeOFF® Family product

(See back page for Replacement Components and ToeOFF/BlueROCKER ordering information)

# COMBO™

Lightweight, Low Profile,  
Functional Orthotic Solution

... for the management of genu-recurvatum  
accompanied with drop foot.



- Uprights are easily attached to anatomically shaped thigh cuff that comfortably grasps the femur for stable fixation.
- Quick connect/release buckles easily attach the adjustable Knee Control Popliteal Interface.
- Tibia Connector is pre-contoured to fit the shape of the anterior plate of the ToeOFF/BlueROCKER, yet is shapeable to accommodate variance in calf circumference and still assure close fit to the anterior plate.



## **Therapy, Reimbursement and Patient Friendly!**

- The thigh cuff/knee control assembly is easily removed from the ToeOFF or BlueROCKER.
- Great for rehab programs where extension control may no longer be required as treatment progresses, eliminates the need for a prescription for a 2nd orthosis!
- Great for patient when relaxing and extension control is not required.
- Easy to don and doff
- Quick release buckles and straps

### **WARNING:**

- Weight Limit: 330 pounds
- Height Limit: 6 ½ feet (2m)
- Use of COMBO with any product other than ToeOFF or BlueROCKER is prohibited
- The COMBO KAFO requires a prescription and must be fit by or under the supervision of a Certified Orthotist.

ToeOFF Item No. Left	ToeOFF Item No. Right	Size	Footplate length	Height
28375 1010	28375 2010	X-Small	8 1/4"	14"
28375 1011	28375 2011	Small	9"	15"
28375 1012	28375 2012	Medium	9 5/8"	16"
28375 1013	28375 2013	Large	10 5/8"	17"
28375 1014	28375 2014	X-Large	11 1/4"	17"



BlueROCKER Item No. Left	BlueROCKER Item No. Right	Size	Footplate length	Height
28405 1010	28405 2010	X-Small	8 1/4"	14"
28405 1011	28405 2011	Small	9"	15"
28405 1012	28405 2012	Medium	9 5/8"	16"
28405 1013	28405 2013	Large	10 5/8"	17"
28405 1014	28405 2014	X-Large	11 1/4"	17"

SoftKIT Item No. Left	ComfortKIT Item No. Right	Description	Size
28390 0010	28398 0010	Interface for ToeOFF & BlueROCKER	X-Small
28390 0011	28398 0011	Interface for ToeOFF & BlueROCKER	Small
28390 0012	28398 0012	Interface for ToeOFF & BlueROCKER	Medium
28390 0013	28398 0013	Interface for ToeOFF & BlueROCKER	Large/X-Large

### COMBO Replacement Components

Item No.	Description
28790 0000	Upright Screws, Size M4x5, Set of 8
28791 0000	Thumb Screw with Teflon Washers and Screws
28792 0000	Buckle Set to Attach Popliteal Interface (Each)
28793 0000	Screw (Size M3x6) Set Only for Popliteal Interface Buckles (Set of 4)
28794 0000	Thigh Strap
28795 0000	D-Ring for Thigh Cuff
28796 0000	Calf Strap
28797 0011	MicroFIX for Thigh Cuff SoftKIT Sizes Small & Medium
28797 0013	MicroFIX for Thigh Cuff SoftKIT Sizes Large & X-Large

**COMBO™**  
a ToeOFF® Family product